

ka

wa



ro

wer

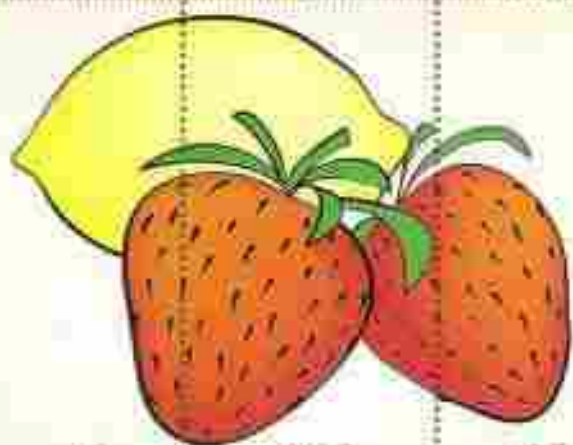

o

wo

ce

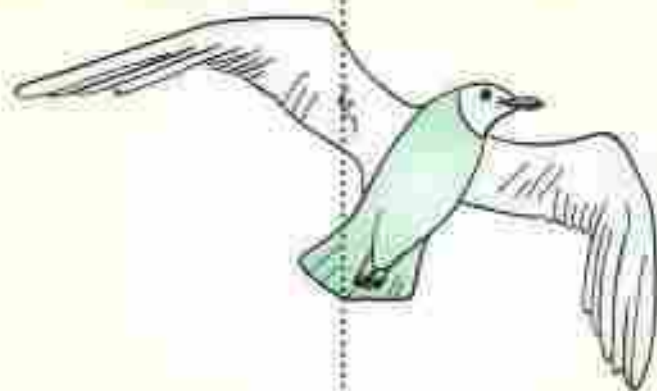

me

wa

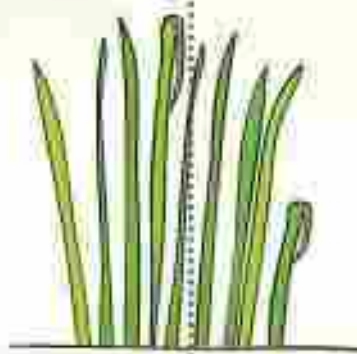

tra

wa

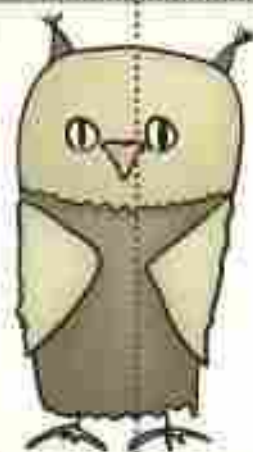

so

wa



ście

wak



kra

wat



w

f



w

f



w

f

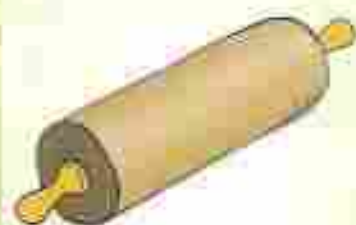

w

f



w

f



w

f



w

f



w

f



w

f



w

f



w

f



w

f



w

f



w

f



w

f



w

f

fajka

wanna

foka

wałek

wełna

fala

futro

welon

fartuch

wata

fontanna

fortepian

warkocze

fasola

worek

wianek

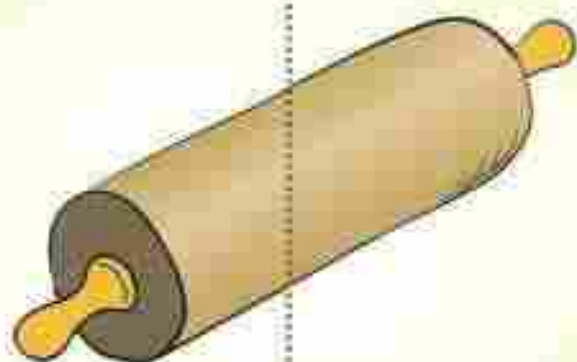

wa

łek

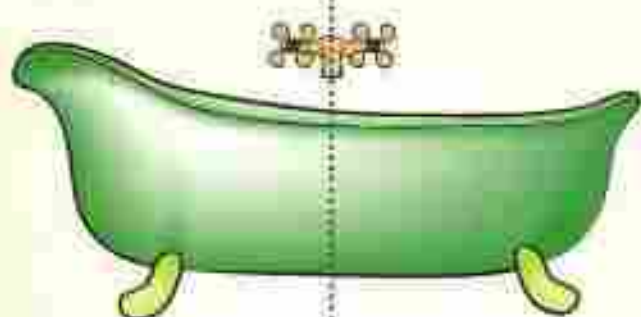

wan

na

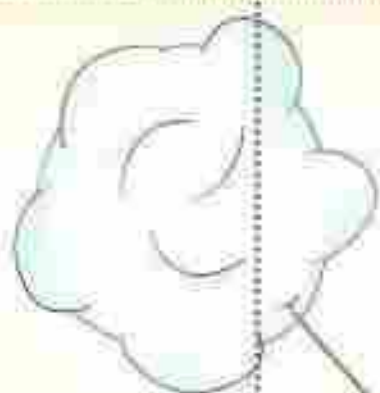

wa

ta



we

lon

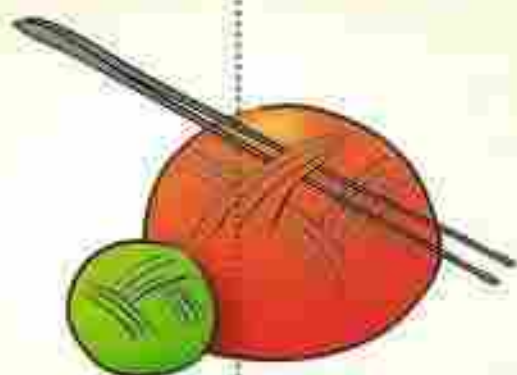

wel

na

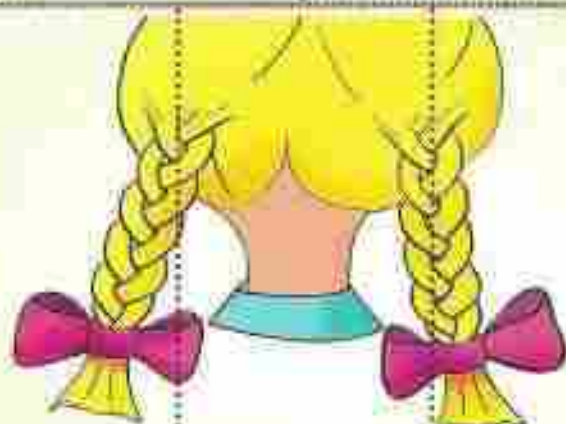

war

ko

cze

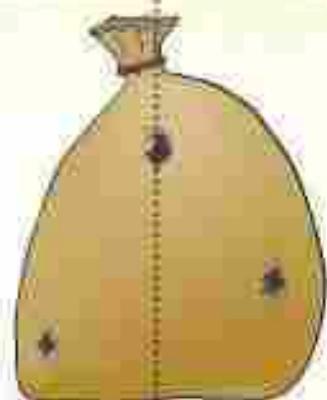

wo

rek



wia

nek



ża

kiet

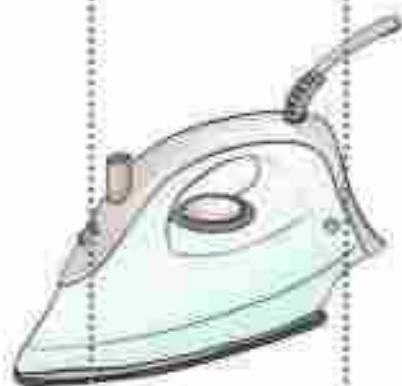

że

laz

ko

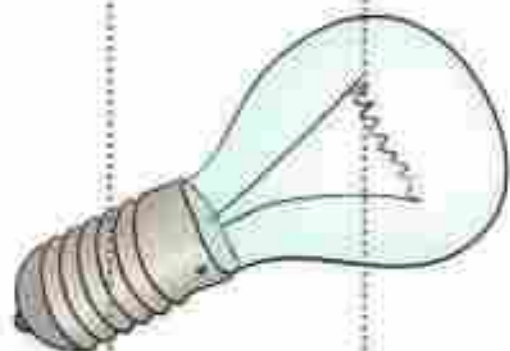

ża

rów

ka



żon

kil

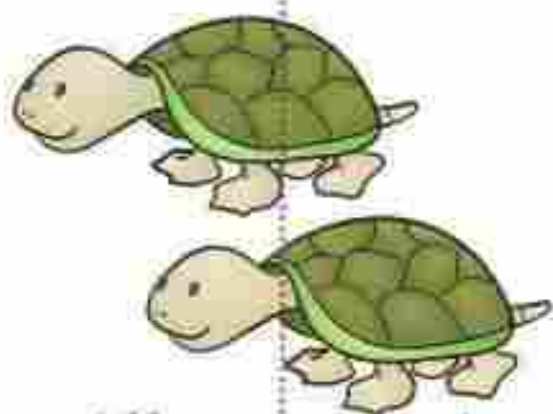

żół

wie

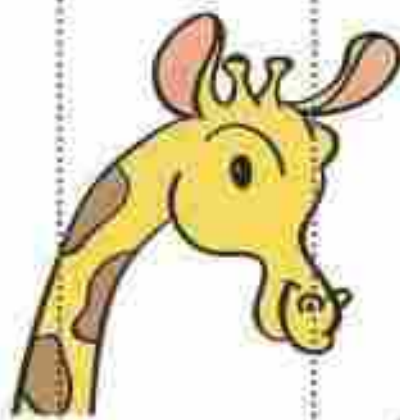

ży

ra

fa

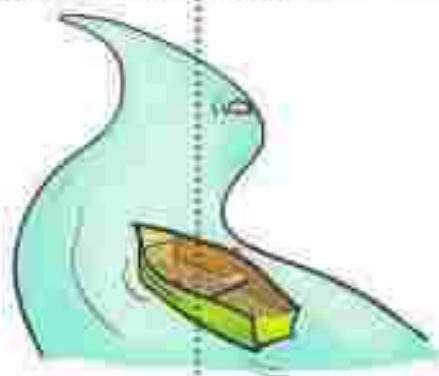

rze

ka



rze

pa



z

s

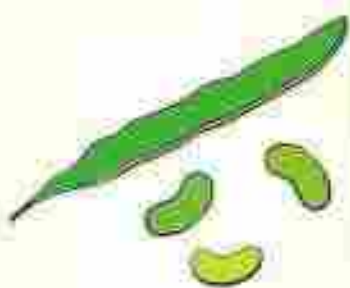

z

s



z

s



z

s



z

s



z

s



z

s



z

s



z

s



z

s



z

s



z

s



z

s

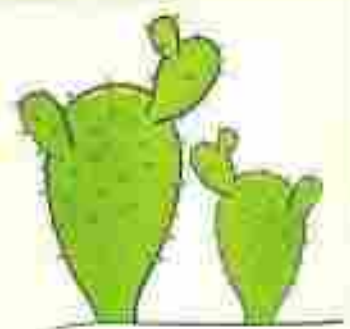

z

s



z

s

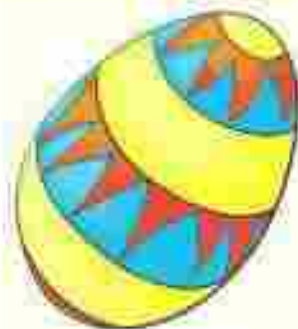

z

s

karuzela

fasola

kasa

koza

lizak

lasek

osa

mazak

prezent

pasek

parasol

fryzura

wazon

kaktusy

piasek

pisanka



ka ru ze la

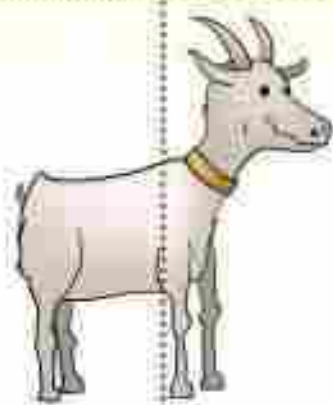

ko za



li zak

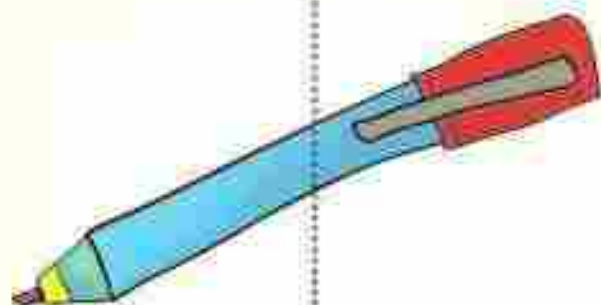

ma zak



pre zent

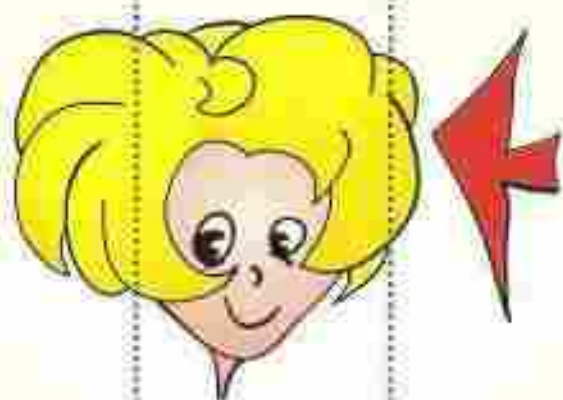

fry zu ra



wa zon



wó zek



ka ru ze la

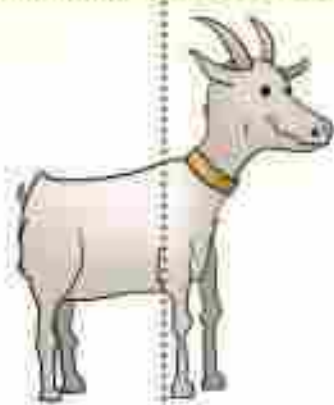

ko za



li zak

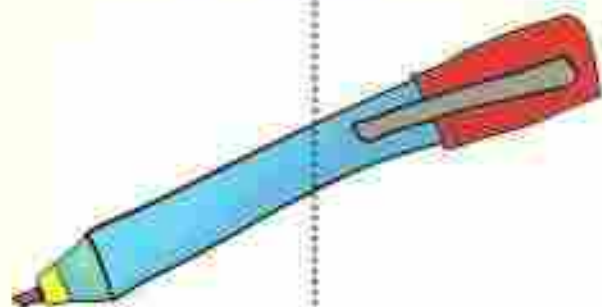

ma zak



pre zent

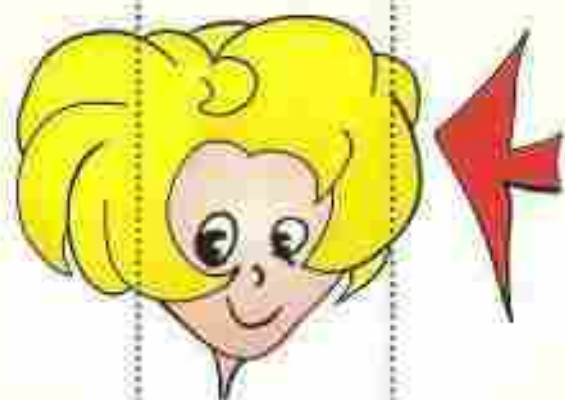

fry zu ra



wa zon



wó zek



z

s



z

s



z

s



z

s



z

s



z

s



z

s



z

s



z

s



z

s



z

s



z

s



z

s



z

s



z

s



z

s

zero

serek

samolot

zasłona

zapalka

sarna

sanki

zupa

soki

sople

zajac

zeszyt

sukienka

salata

zapalniczka

znaczek



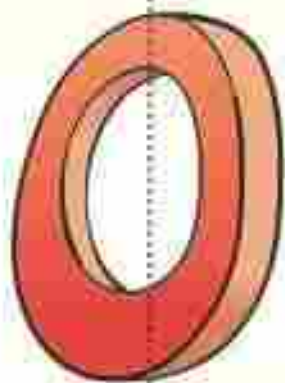

ze

ro



za

sło

na



za

pał

ka



zu

pa



za

jąc

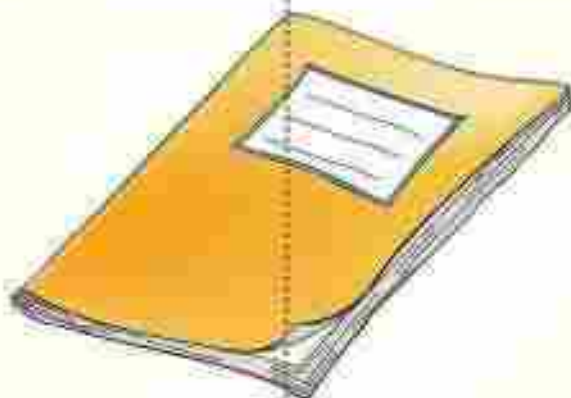

ze

szył

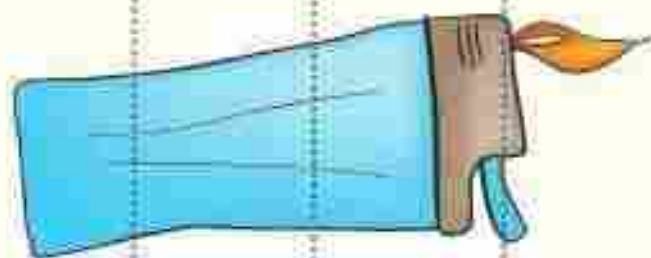

za

pal

nicz

ka



zna

czek



w f



w f



w f



w f



w f



w f



w f

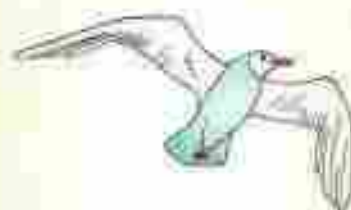

w f



w f



w f



w f



w f



w f



w f



w f



w f

kawa

kufel

kaloryfer

rower

owoce

kufer

mikrofon

mewa

szafa

trawa

sowa

szufelka

śpiewak

krawat

syfon

kafelki



ż(rz) sz



ż(rz) sz



ż(rz) sz



ż(rz) sz



ż(rz) sz



ż(rz) sz



ż(rz) sz



ż(rz) sz

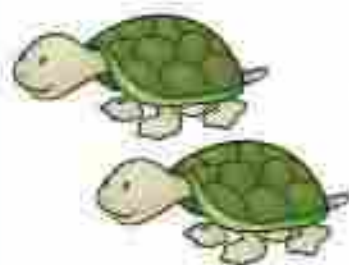

ż(rz) sz



ż(rz) sz



ż(rz) sz



ż(rz) sz



ż(rz) sz



ż(rz) sz



ż(rz) sz



ż(rz) sz

żakiet

szafa

szalik

żelazko

żarówka

żonkil

szopa

szynka

żółwie

żyrafa

szorty

rzeka

rzepa

szeryf

szufelka

szalás

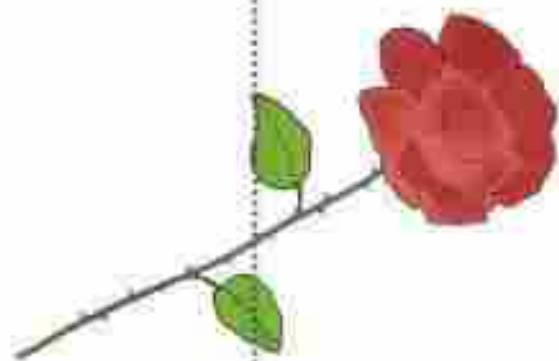

ró

ża

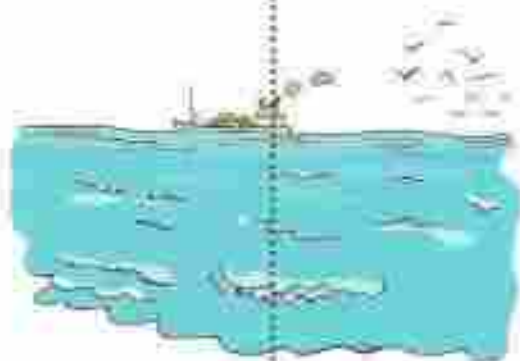

mo

rze

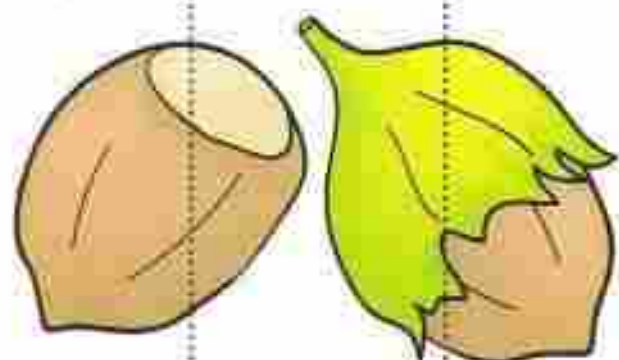

o

rze

chy

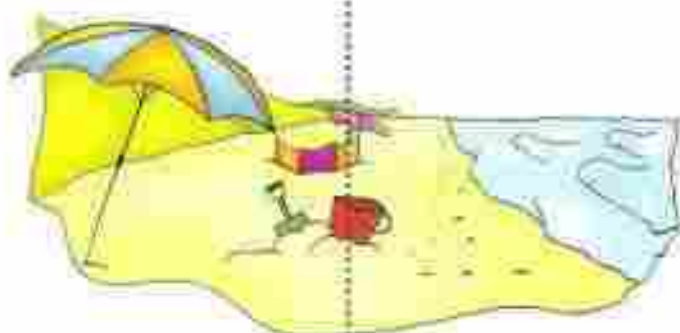

pla

ża



stra

żak



wie

ża

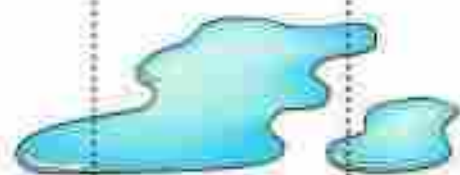

ka

tu

ża

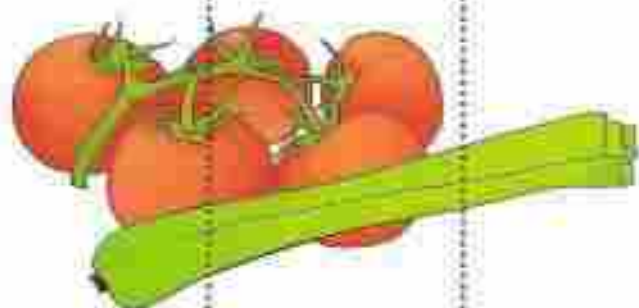

wa

rzy

wa



ż(rz)

sz



ż(rz)

sz



ż(rz)

sz



ż(rz)

sz



ż(rz)

sz



ż(rz)

sz



ż(rz)

sz

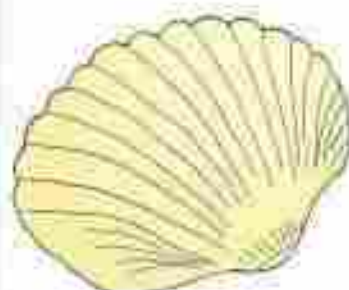

ż(rz)

sz



ż(rz)

sz



ż(rz)

sz



ż(rz)

sz



ż(rz)

sz



ż(rz)

sz



ż(rz)

sz



ż(rz)

sz



ż(rz)

sz

róża

morze

łańcuszek

koszyk

orzechy

plaża

kalosze

muszelka

strażak

wieża

kieliszek

koszula

kałuża

warzywa

wieszak

nosze



zi

ma



zio

ła



Zie

mia

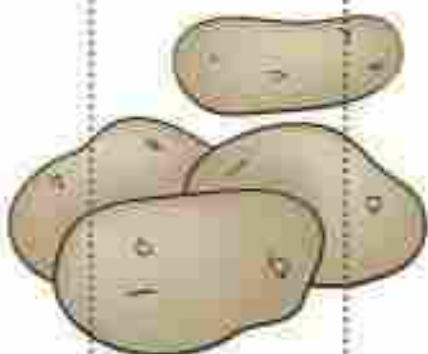

ziem

nia

ki

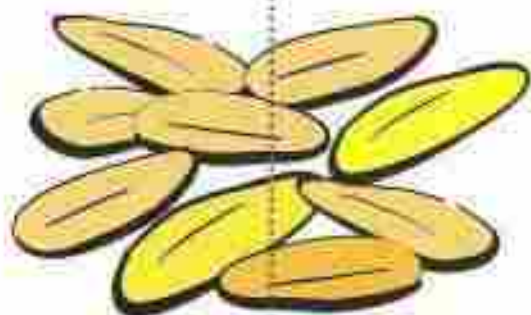

ziar

no



zie

leń



Ziu

tek

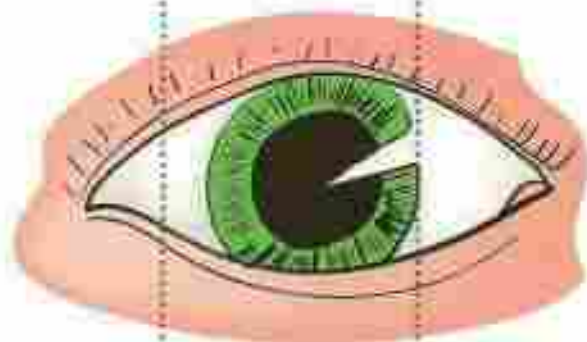

źre

ni

ca



*ż(zi)*      *ś(si)*

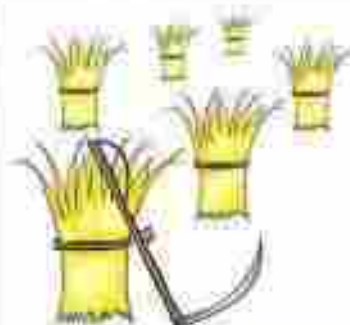

*ż(zi)*      *ś(si)*



*ż(zi)*      *ś(si)*



*ż(zi)*      *ś(si)*

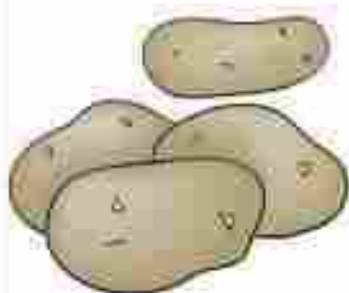

*ż(zi)*      *ś(si)*



*ż(zi)*      *ś(si)*



*ż(zi)*      *ś(si)*



*ż(zi)*      *ś(si)*



*ż(zi)*      *ś(si)*



*ż(zi)*      *ś(si)*



*ż(zi)*      *ś(si)*



*ż(zi)*      *ś(si)*

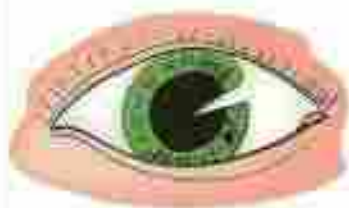

*ż(zi)*      *ś(si)*



*ż(zi)*      *ś(si)*



*ż(zi)*      *ś(si)*



*ż(zi)*      *ś(si)*

*zima*

*siano*

*siatka*

*ziola*

*ziemniaki*

*siekiera*

*sito*

*ziarno*

*śmietana*

*zielen*

*śpiewak*

*Ziutek*

*żrenica*

*śliniaczek*

*sikorka*

*śmietnik*



je      zio      ro

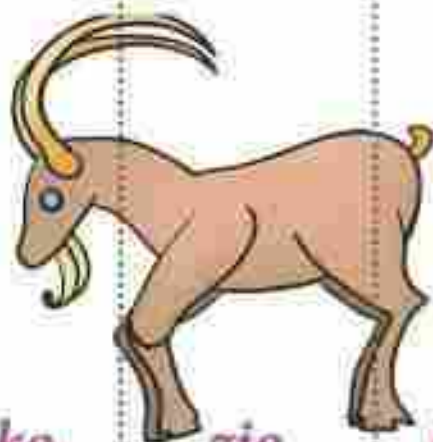

ko      zio      lek

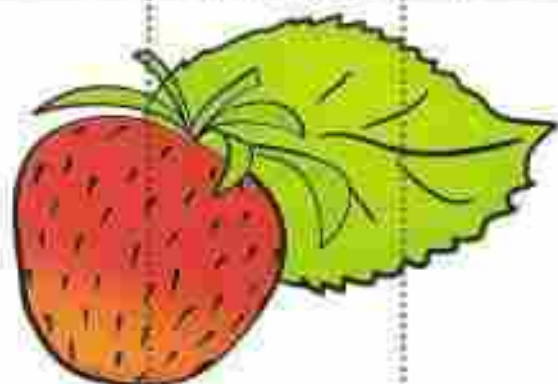

po      ziom      ka



ła      zien      ka



wię      zien



woż      na



Jó      zio



woż      ni      ca





ż(zi)      ś(si)



ż(zi)      ś(si)



ż(zi)      ś(si)



ż(zi)      ś(si)



ż(zi)      ś(si)



ż(zi)      ś(si)



ż(zi)      ś(si)



ż(zi)      ś(si)



ż(zi)      ś(si)



ż(zi)      ś(si)



ż(zi)      ś(si)



ż(zi)      ś(si)



ż(zi)      ś(si)



ż(zi)      ś(si)



ż(zi)      ś(si)



ż(zi)      ś(si)

jezioro

jesień

misie

koziolatek

poziomka

nasiona

osioł

łazienka

więzień

prosiak

woźna

Józio

wisienka

tasiemka

woźnica

strusie

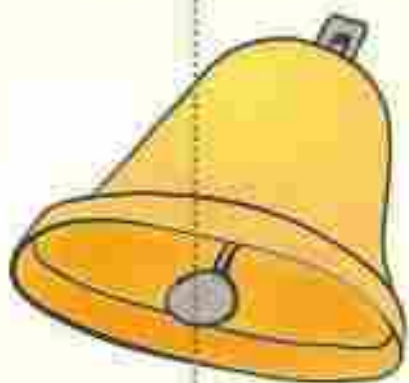

dzwo

nek

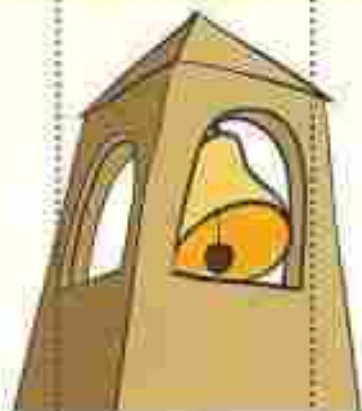

dzwon

ni

ca

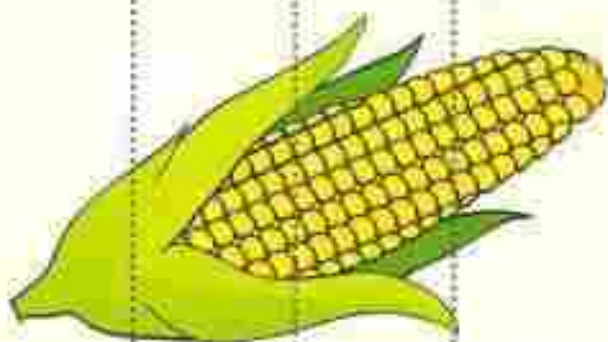

ku

ku

ry

dza

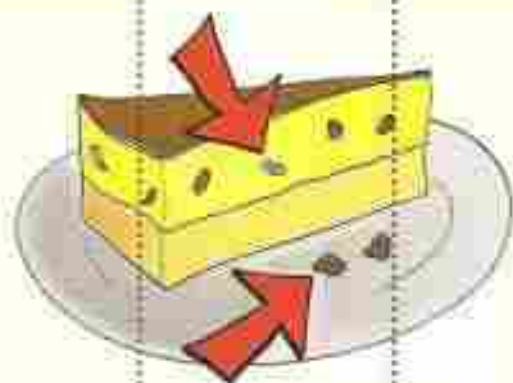

ro

dzy

ki

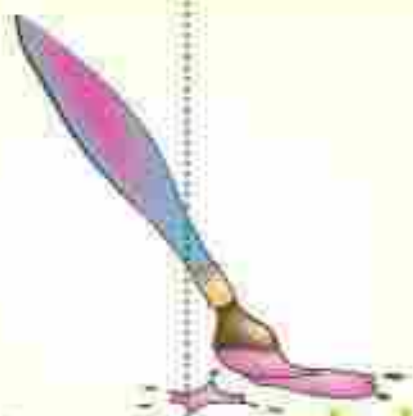

pę

dzel

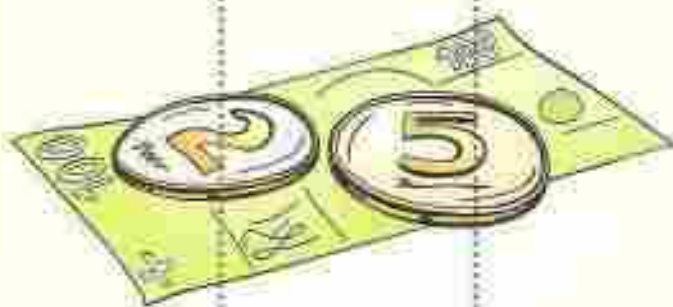

pie

nią

dze



ko

le

dzy

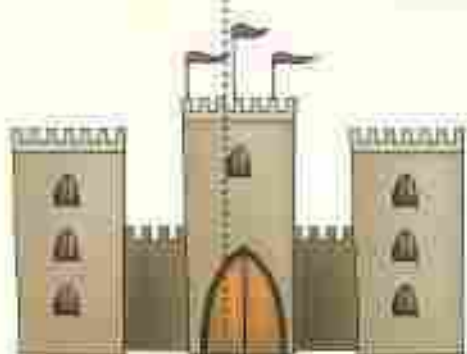

twier

dza



dz c

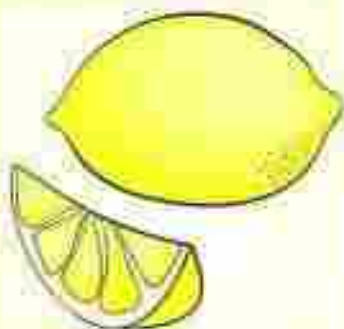

dz c



dz c



dz c



dz c



dz c



dz c



dz c



dz c



dz c



dz c



dz c



dz c



dz c



dz c



dz c

dzwonek

cytryna

dzwonnica

cukierek

kukurydza

rodzynki

rycerz

plecak

pędzel

pieniądze

owoce

taca

koledzy

twierdza

ręce

kotwica



dż

cz



dż

cz



dż

cz



dż

cz



dż

cz



dż

cz



dż

cz



dż

cz



dż

cz



dż

cz



dż

cz



dż

cz



dż

cz



dż

cz



dż

cz



dż

cz

dżemy

czapka

dżokej

czajnik

dżentelmen

dżuma

czosnek

czereśnie

dżdżownica

czapla

czepek

dżoker

dżojstik

czupryna

dżinsy

czarodziej

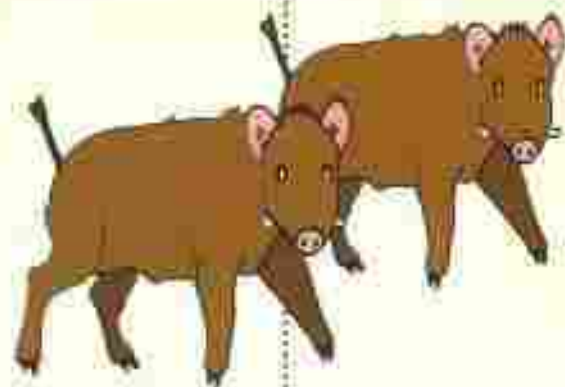

dzi

ki



dziup

ła



dziew

czyn

ka

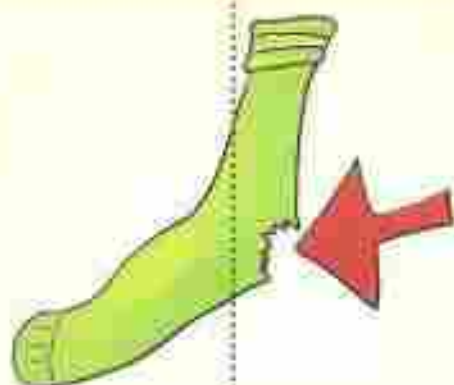

dziu

ra



praw

dzi

wek

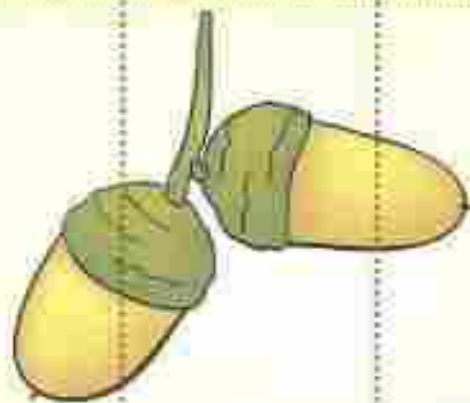

żo

łę

dzie



cza

ro

dziej

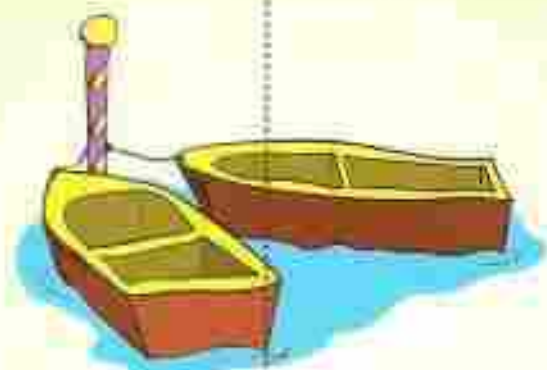

ło

dzie



*dź(dzi) ć(ci)*



*dź(dzi) ć(ci)*



*dź(dzi) ć(ci)*



*dź(dzi) ć(ci)*



*dź(dzi) ć(ci)*



*dź(dzi) ć(ci)*



*dź(dzi) ć(ci)*

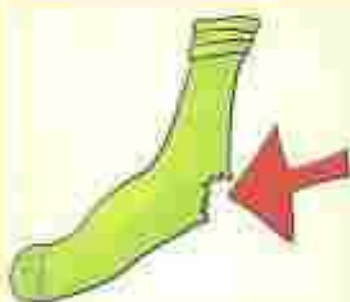

*dź(dzi) ć(ci)*



*dź(dzi) ć(ci)*



*dź(dzi) ć(ci)*



*dź(dzi) ć(ci)*

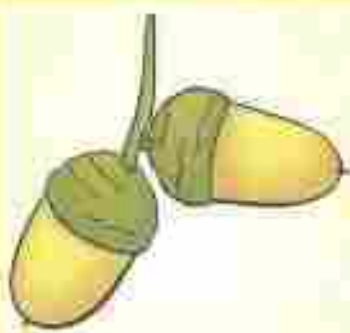

*dź(dzi) ć(ci)*



*dź(dzi) ć(ci)*



*dź(dzi) ć(ci)*



*dź(dzi) ć(ci)*



*dź(dzi) ć(ci)*

*cielę*

*cień*

*dziki*

*dziupła*

*ciastko*

*kociak*

*dziewczynka*

*dziura*

*kociol*

*kwiaciarnia*

*prawdziwek*

*żołędzie*

*czarodziej*

*wycieraczka*

*nici*

*łodzie*



ba

lon

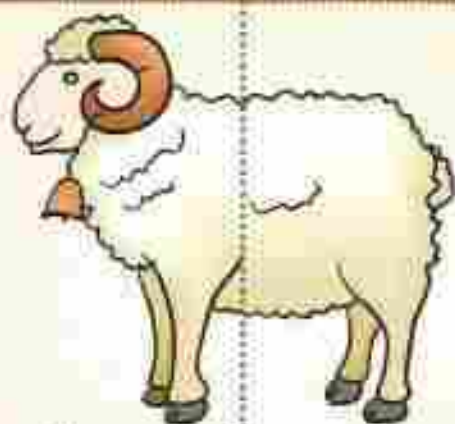

ba

ran



bał

wan



becz

ka

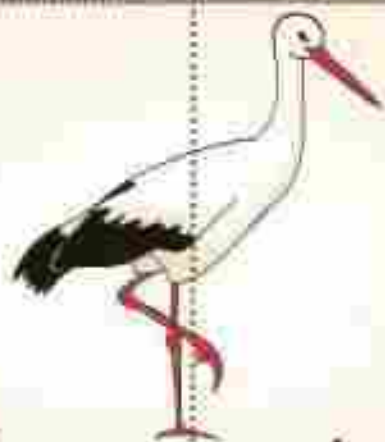

bo

cian



bu

rak



bu

ty

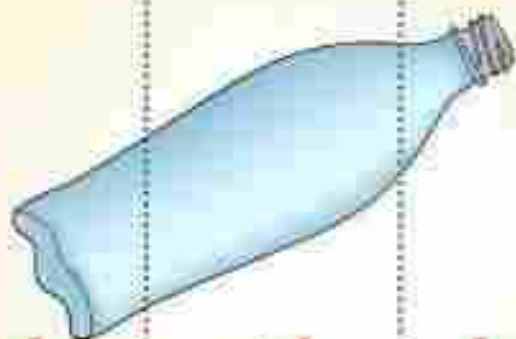

bu

tel

ka



b

p



b

p



b

p



b

p



b

p



b

p



b

p



b

p



b

p



b

p



b

p



b

p



b

p



b

p



b

p



b

p

balon

pająk

baran

bałwan

palma

parasol

beczka

beret

bocian

pasek

pałac

burak

patelnia

buty

butelka

pędzelek



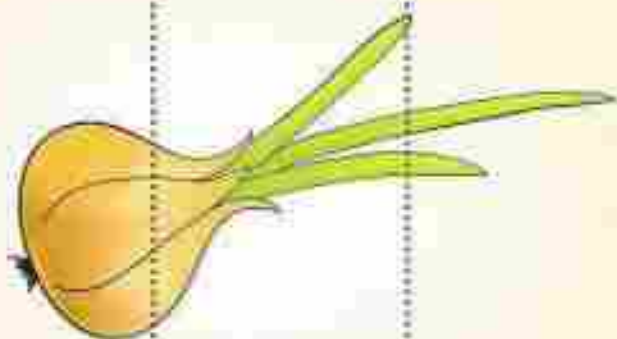

ce bu la



ku bek

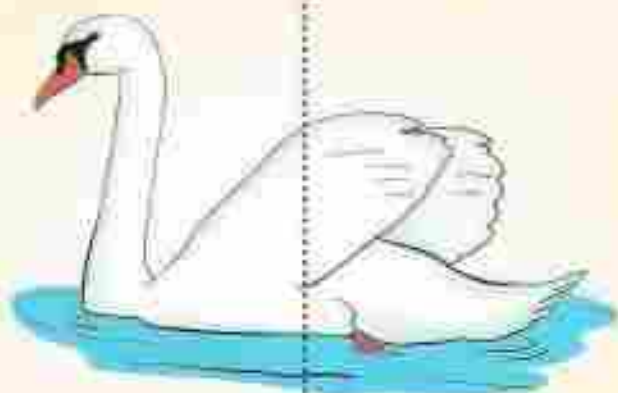

ła bęź

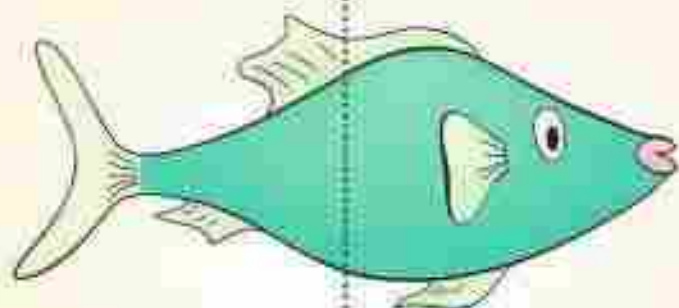

ry ba

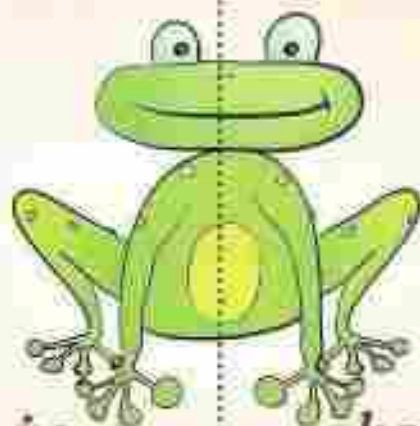

ża ba

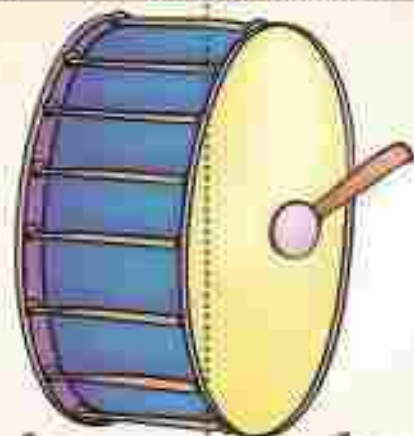

bę ben

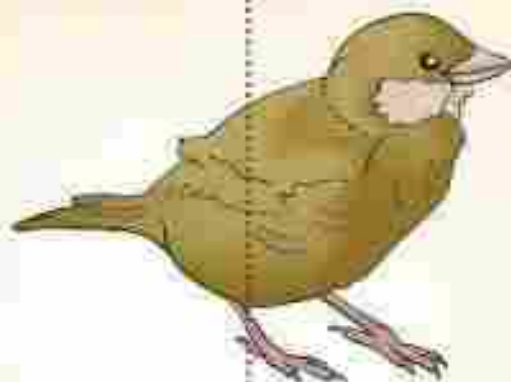

wró bel

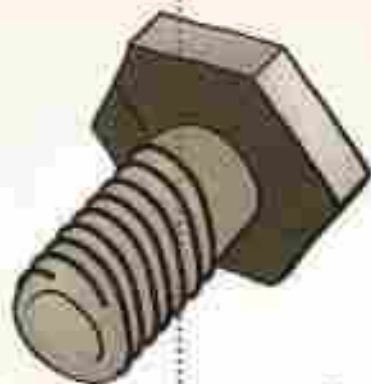

śru ba



b

p



b

p



b

p



b

p



b

p



b

p



b

p

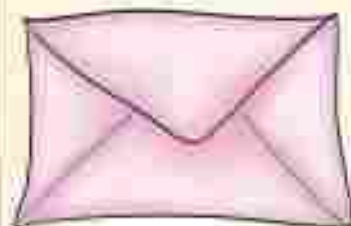

b

p



b

p



b

p

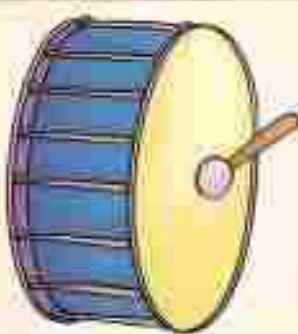

b

p



b

p



b

p



b

p



b

p



b

p

kanapa

cebula

kubek

kapelusz

kapusta

łabędź

ryba

koperta

łopata

żaba

bęben

lupa

aparat

wróbel

śruba

czepek

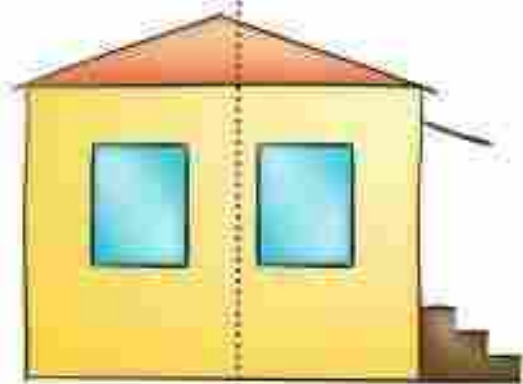

do

mek

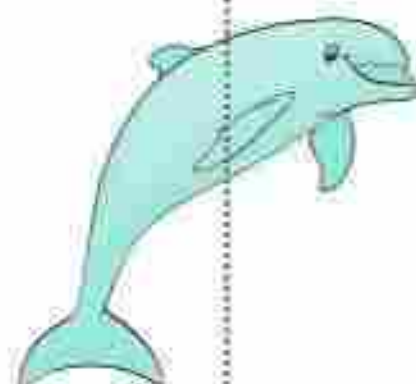

del

fin

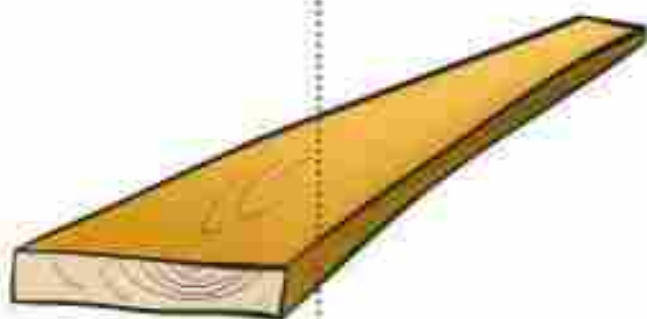

des

ka

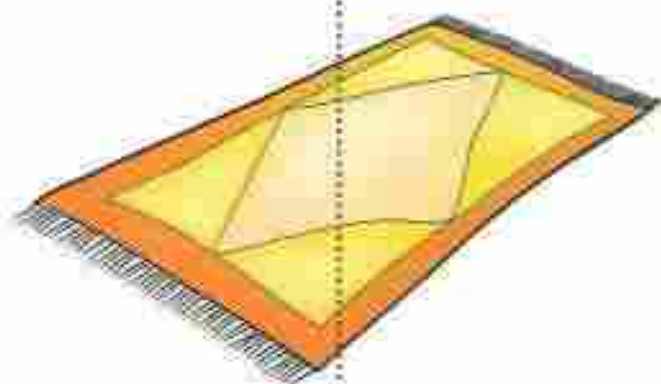

dy

wan



do

nicz

ka



dy

nia

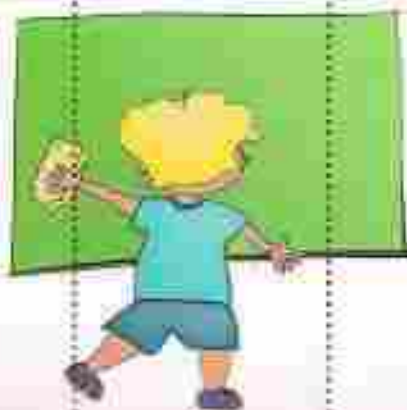

dy

żu

rny

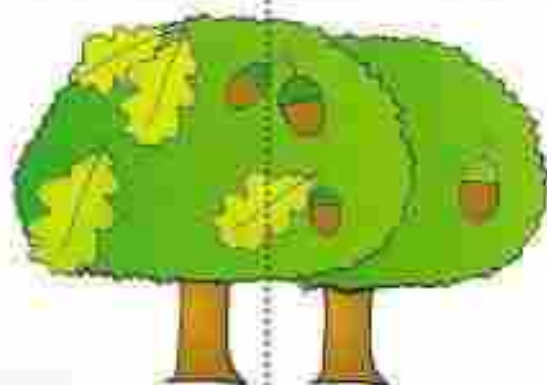

dę

by



d

t



d

t



d

t



d

t

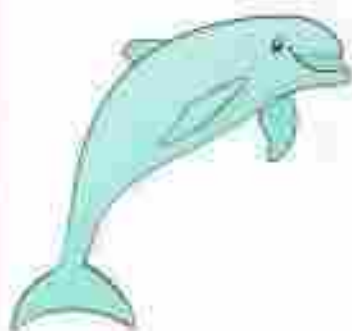

d

t



d

t



d

t



d

t



d

t



d

t



d

t



d

t



d

t



d

t



d

t



d

t

tablica

domek

taczka

telefon

delfin

deska

telewizor

torebka

dywan

doniczka

tulipan

tenisówki

dynia

dyżurny

dęby

termos



bu

da



lo

dy

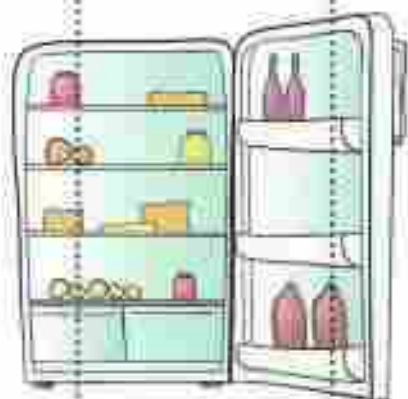

lo

dów

ka

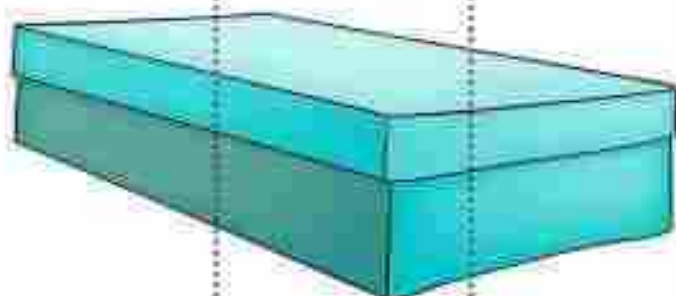

pu

del

ko

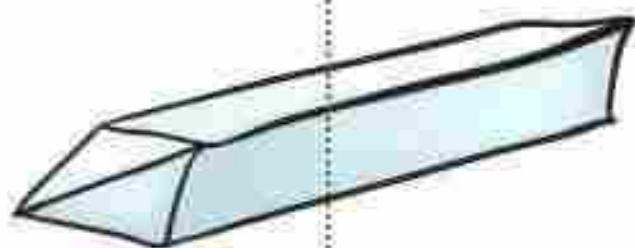

kre

da



wi

de

lec



wia

der

ko



me

dal



bu

da



lo

dy

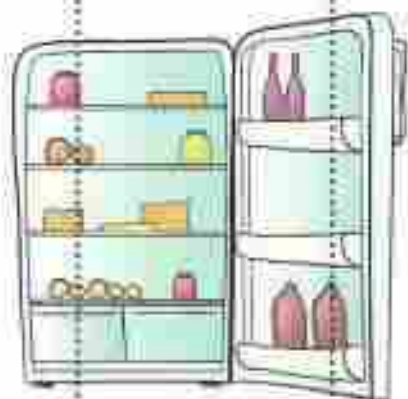

lo

dów

ka

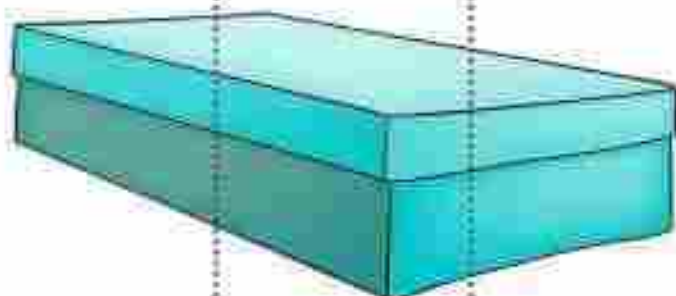

pu

del

ko

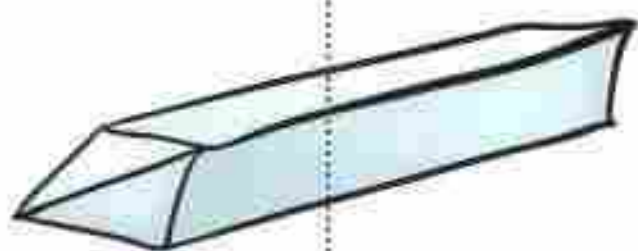

kre

da



wi

de

lec

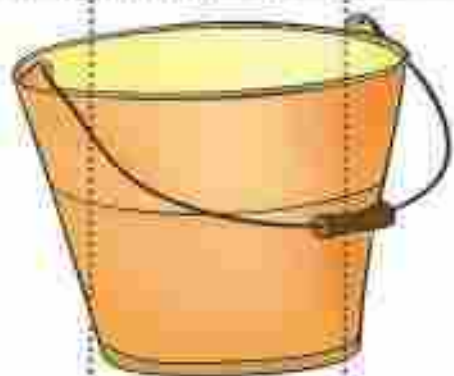

wia

der

ko



me

dal



d t



d t



d t



d t



d t



d t



d t



d t

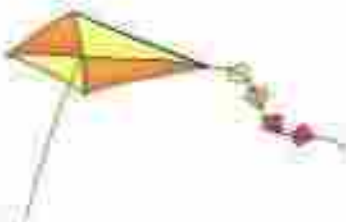

d t



d t



d t



d t



d t



d t



d t



d t

buda

armata

lody

lodówka

fotel

młotek

pudelko

kreda

latawiec

rakieta

widelec

wiaderko

motor

sweter

medal

sałata

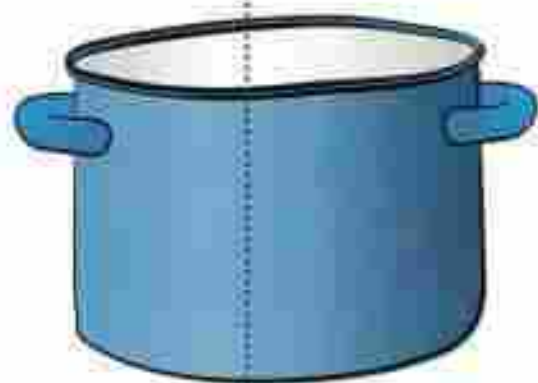

gar

nek



ga

ze

ta



go

łab



gó

ral



gu

zik

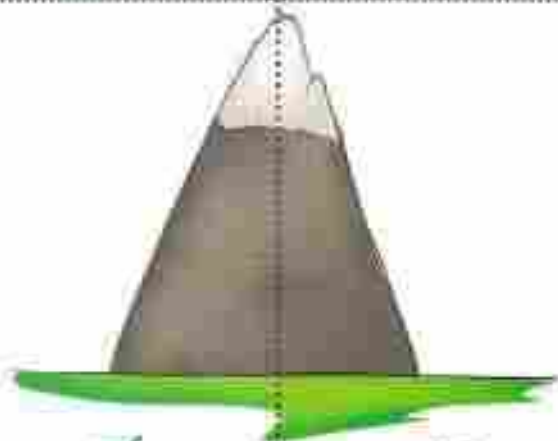

gó

ra



gi

ta

ra

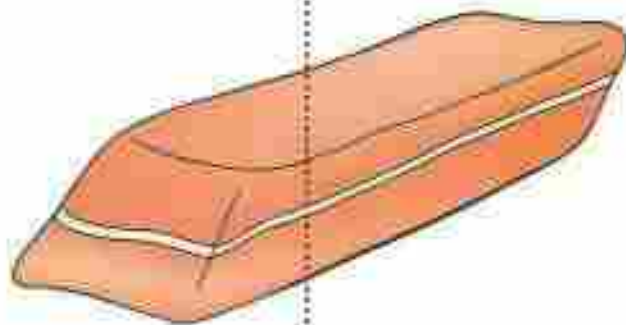

gum

ka





g k



g k



g k



g k



g k



g k



g k



g k



g k



g k



g k



g k



g k



g k

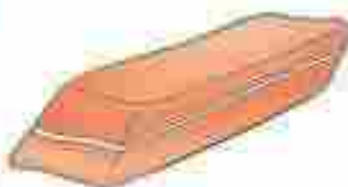

g k



g k

kalendarz

garnek

gazeta

korale

koza

gołąb

góral

kalosze

kościół

guzik

góra

kamień

kalafior

gitara

gumka

kura

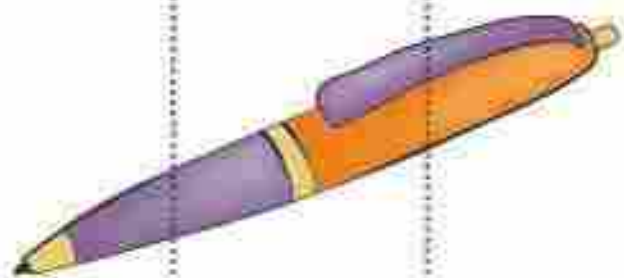

dlu go pis

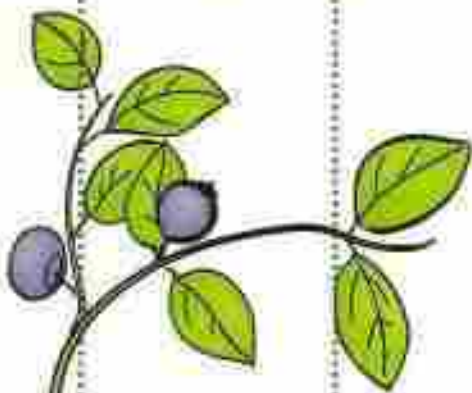

ja go dy



ko gut

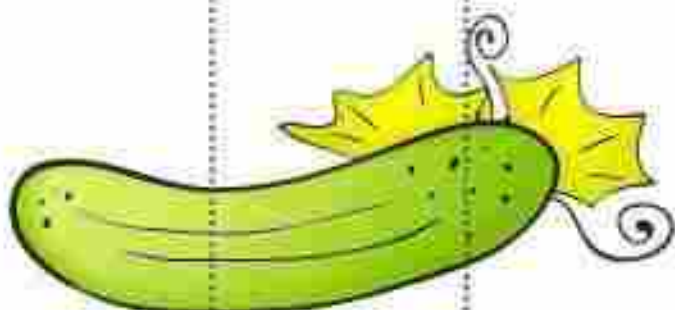

o gó rek



pa pu ga

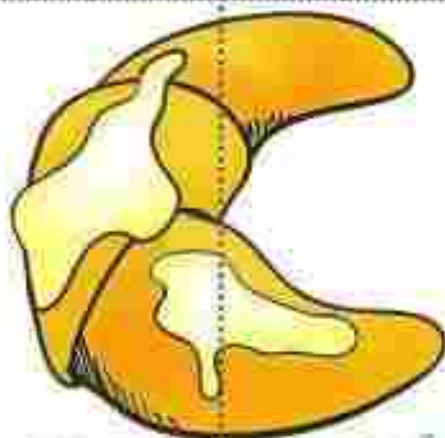

ro gal

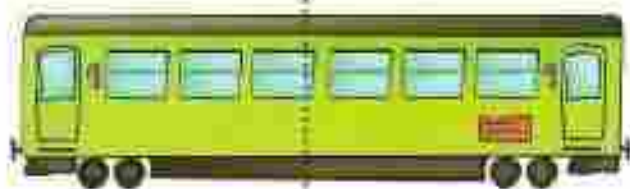

wa gon



ze gar



g k



g k



g k



g k



g k



g k

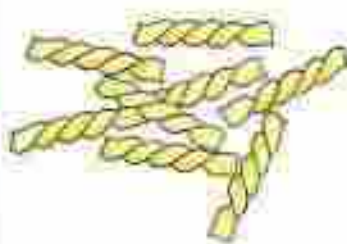

g k



g k



g k

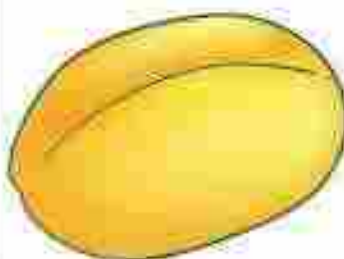

g k

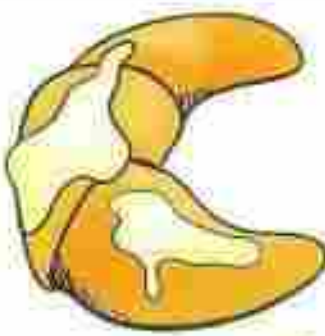

g k



g k

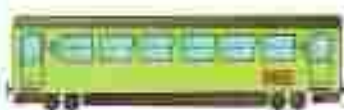

g k

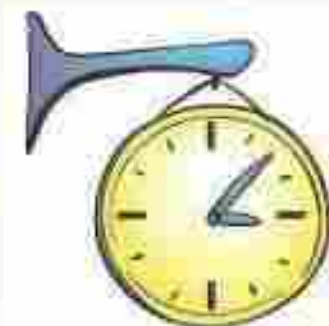

g k



g k



g k

okulary

długopis

jagody

kogut

foka

oko

makaron

ogórek

papuga

bułka

rogal

krokodyl

wagon

zegar

zakonnica

pokój